

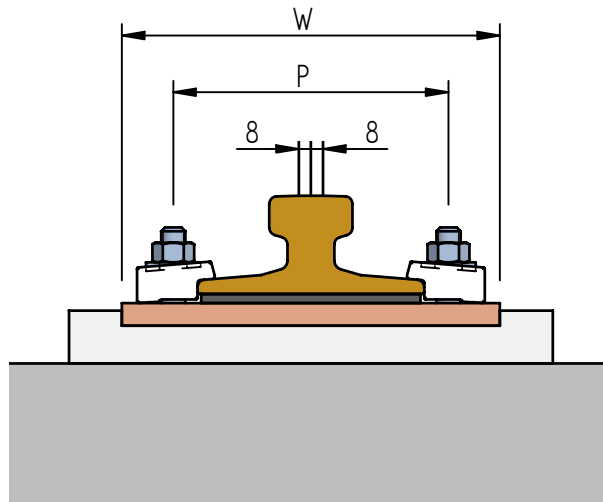

adjustable rail clip

AM16



Distance between studbolt M16	P	Rail base + 32	[mm]
Minimum assembly width clips	W	Rail base + 96	[mm]
Nominal width sole plate with anchorbolts	W	Rail base + 110	[mm]

