

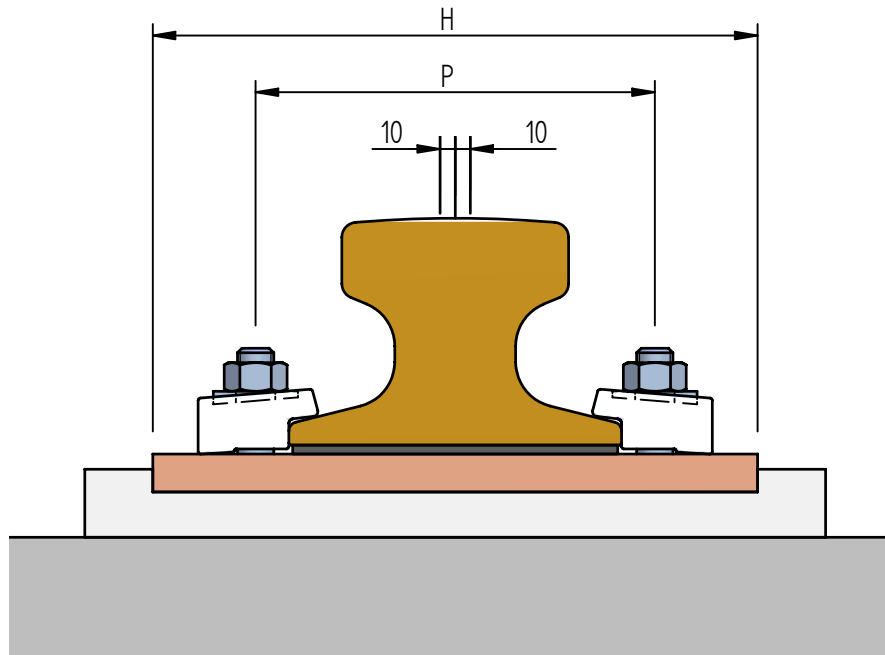

Adjustable rail clip

AM24



Distance between studbolt M24	P	Rail base + 44	[mm]
Minimum assembly width clips	W	Rail base + 140	[mm]
Nominal width sole plate with anchorbolts	W	Rail base + 140	[mm]

